

# CORRA

## GX-8000 PLUS

# 3D SCANNER

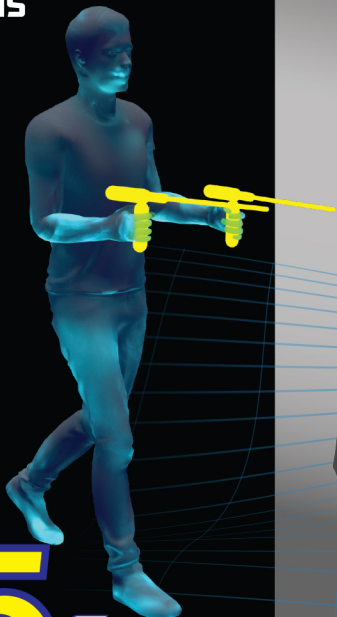

# USER MANUAL

# 5 SEARCH SYSTEMS

The CORRA logo features the word 'CORRA' in a bold, black, sans-serif font. A red and white stylized cobra head is positioned behind the letters 'O', 'R', and 'A'. Below the word 'CORRA', the letters 'CORRA' are repeated in a red, outlined font.

# CORRA

## GX-8000 PLUS





## Introduction

Based on “changing the concept of technology in the world” principle, it was imperative to work hard and develop years of expertise and experiences in the field of metal detectors.

The main objective was to develop a product that meets the highest quality standards so that this product be a top in detector technology.

Putting an end to years of technical errors in this field, Cobra products were developed by Geo Ground, the leading German company in geophysical measurement and detection technologies underground with a clear goal of accessing this technology to all prospectors, by developing easy-to-use technologies at an affordable price for all prospectors and those looking to reach their golden dreams.



## Contents

Introduction	2
Contents	3
Warnings	4
Overview	6
Cobra GX-8000 PLUS	7
Package Contents	8
Main Unit explanation	10
Main unit keypad	11
IONIC unit explanation	12
IONIC unit keypad	13
LRL Unit Explanation	14
GEO UNIT Explanation	15
Systems Explanation	16
LRL Search	20
IONIC Search	35
IONIC System	36
ION System	40
BIONIC System	44
GEOGROUND 3D Analyzer	49
Main Unit Settings	63
IONIC Unit Settings	67
Specifications	71





## WARNINGS

COBRA GX 8000 Plus is an is a state-of-the-art electronic device. Don't assemble or operate the device before you read the user's manual and don't store the device and its components under extreme low or high temperatures for long periods.

- The suitable temperature for storage is from - 20 to 60 Celsius /about 4 to 140 Fahrenheit degrees.
- Don't immerse the device or its attached parts in water. Don't expose the equipment to extremely humid environments.
- Protect the main unit of the device from the impacts during the normal use .
- For shipping , put the detector carefully and safely in the original carton inside shock-resistant packaging.
- It isn't allowed to disassemble or repair COBRA GX 8000 except by Geoground company or their authorized service centers.
- Unauthorized disassembly/ intrusion into the internal components of the main device unit or other units for any reason, will cancel the warranty.



## Notice

Do not use the device indoors. The device may constantly give target signals indoors where there are many metals present.

- Use the device outdoors, in open fields.

-Do not leave another detector or electromagnetic device close to the device within a distance of less than 10 meters - 30 feet

-Do not carry any metallic objects while using the device.

The device may detect the metals attached to you or to your shoes as targets.

For Consumers within the European Union: Do not dispose of this equipment in general household waste. The crossed wheeled bin symbol on this equipment indicates this unit should not be disposed of in general household waste, but recycled in compliance with local government regulations and environmental requirements

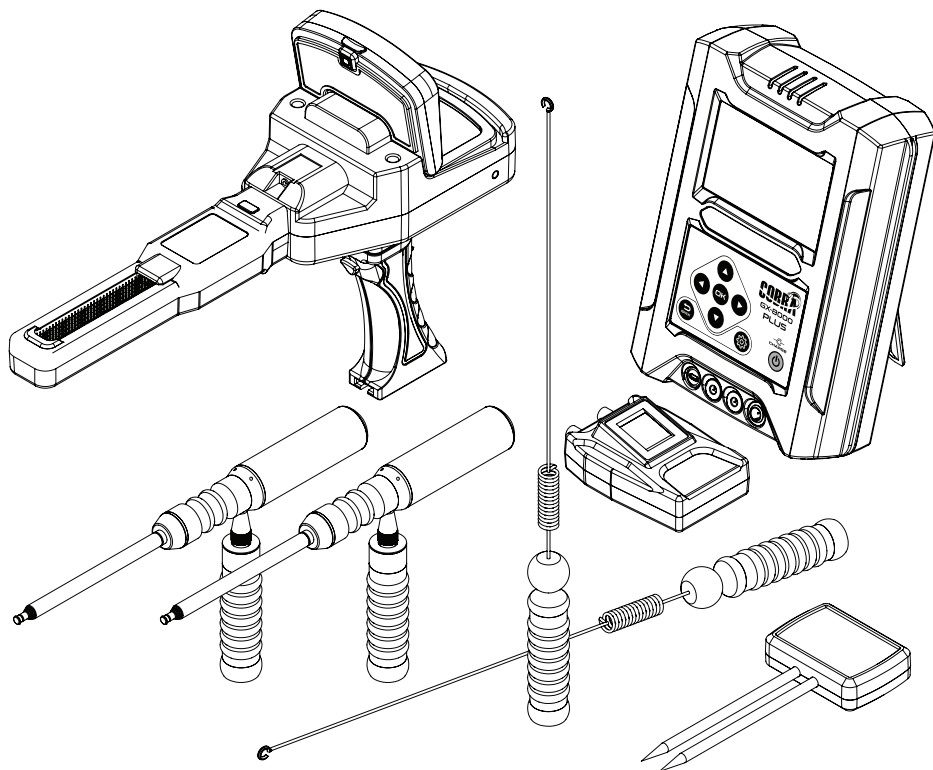



## **COBRA GX 8000 Plus**

COBRA GX 8000 Plus is the most integrated device for detecting gold and metals. It is used for detecting

metals, hunting treasures and excavation of archaeological treasures.

This device meets the professional prospectors' needs who search for treasures and the professional prospectors all over the world.

COBRA GX 8000 includes for the first time in one device for detecting metals, six search systems accompanied with various detecting technologies which offer all the tools and functions needed by professional prospectors and beginners for different applications and tasks related to search activities for treasures and metals detection.

COBRA GX 8000 is a cutting-edge German technology manufactured by Geoground a German based company. This technology is known for detecting metals and gold prospecting all over the world.

This is achieved by the virtue of its high performance, the accurate results and trusted equipment which propose the best solutions.

This is to unleash your passion for the discovery of the treasures by using COBRA GX 8000, which is the best and most reliable device for detecting the deepest buried treasures easily.



## Package contents

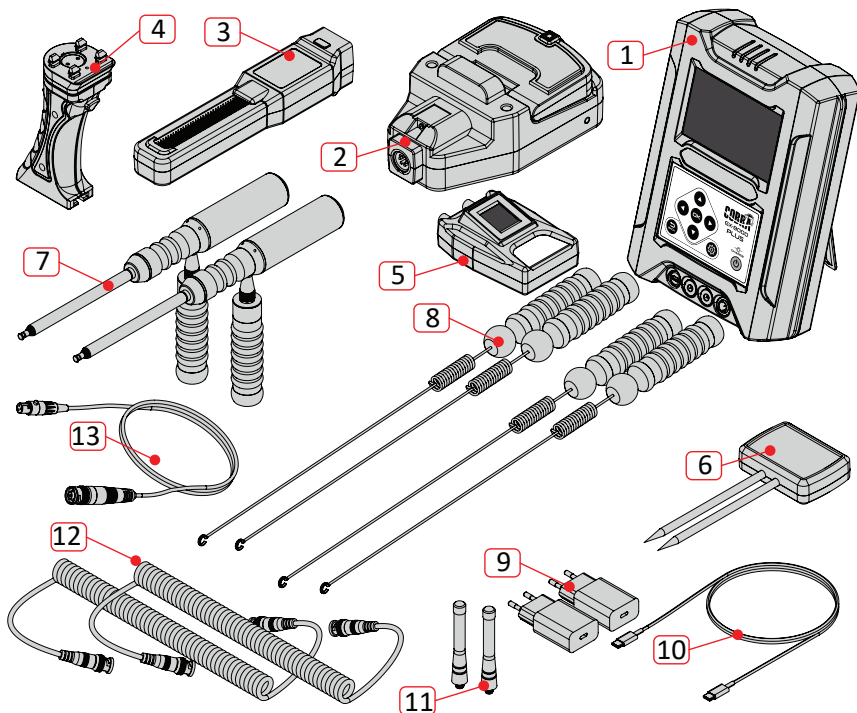



## Package contents

- 1 Main unit
- 2 Ionic unit
- 3 Ionic unit sensor
- 4 Ionic unit handle
- 5 LRL unit
- 6 GEO unit
- 7 LRL Rods for single person
- 8 LRL Rods for dual person
- 9 Device chargers
- 10 Charge cable
- 11 Connection antennas
- 12 LRL connection cables
- 13 GEO connection cable



## Main unit explanation





## Main unit keypad explanation

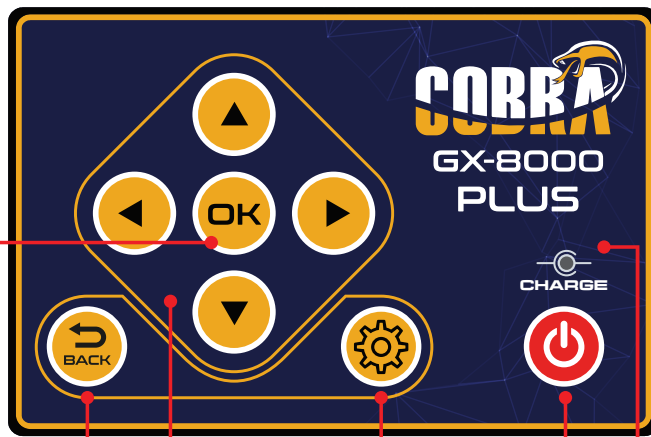

OK Button

Back button

Control arrows

Setting button

Power button

Charge LED





## Ionic unit explanation



- 1- Screen
- 2- Keypad
- 3- Lazer
- 4- Light LED
- 5- I.B.I Sensor
- 6- Sensor Lock
- 7- Charge Jack
- 8- Charge LED
- 9- Device Handle
- 10- Rotation Lock
- 11- Headphone Jack
- 12- Handle charge Jack
- 13- Handle Charge LED

## Ionic unit keys pad explanation

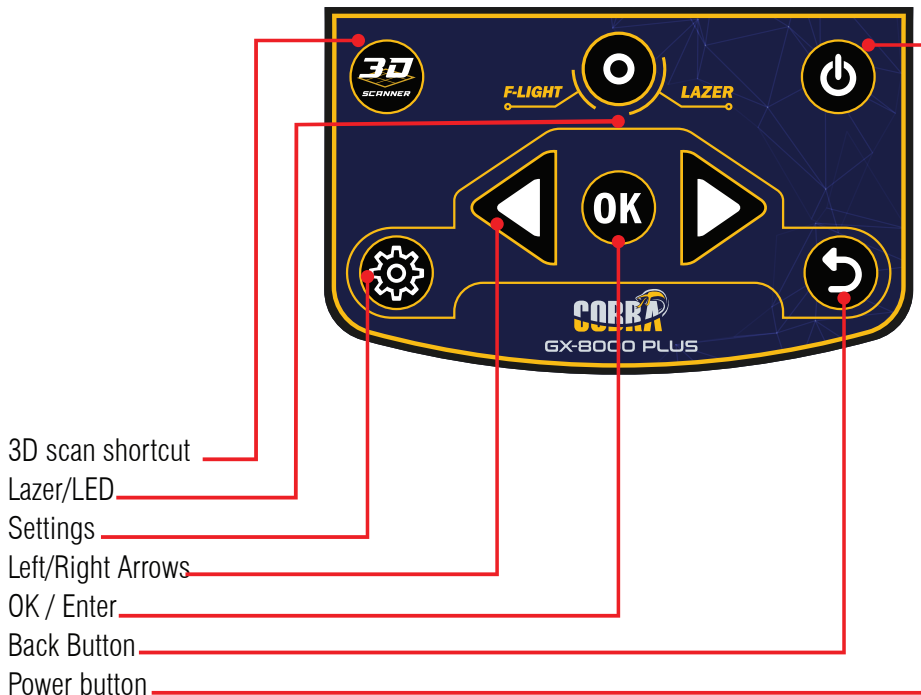



## LRL unit explanation

LRL Screws Cable Jack

Charge Jack

Device Screen

Key Pad

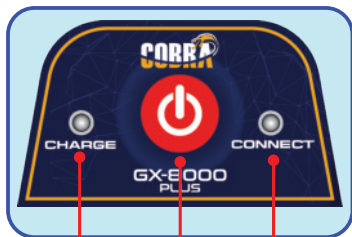

Charge LED

Power Button

Connection LED





## GEO unit explanation

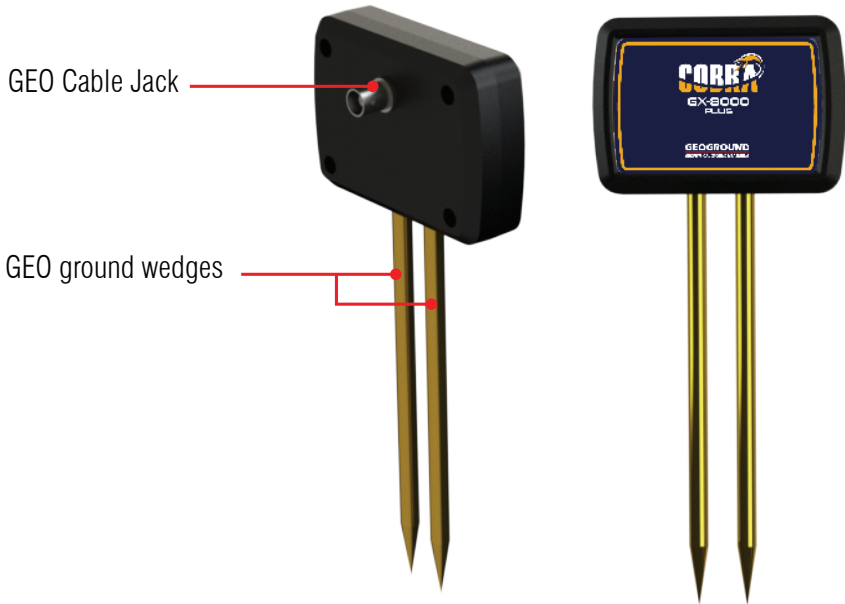



## Systems explanation

Embarking on a treasure hunt often requires the aid of advanced technology to navigate the vast expanses of land or sea. Among the arsenal of tools available to treasure hunters, long-range locator devices stand out as indispensable assets. These systems are engineered to detect hidden treasures or valuable objects from significant distances, employing various cutting-edge technologies to uncover secrets buried beneath the earth or concealed in remote locations. Let's explore five distinct systems tailored to cater to different needs and preferences in the pursuit of adventure and discovery:

### **1. Single Person Long Range Locator:**

Designed for solo adventurers, the single-person long-range locator is a trusty companion for individuals venturing into the unknown. With its sophisticated scanning capabilities and precise targeting, this system empowers lone seekers to cover vast territories with confidence, offering insights into potential treasure troves or hidden artifacts.



## **2. Double Person Long Range Locator:**

For those who prefer companionship on their quest for riches, the double-person long-range locator provides the perfect solution. By accommodating two users simultaneously, this system fosters collaboration and teamwork, amplifying the effectiveness of treasure hunting expeditions. With synchronized operation and expanded coverage, partners can explore remote landscapes with greater efficiency, maximizing the chances of uncovering valuable treasures.

## **3. Ionic System:**

Harnessing the power of ionic technology, this system delves into the unseen world of atmospheric ions to unveil buried treasures and ancient relics. By analyzing subtle variations in ion concentrations, the ionic system identifies anomalies indicative of hidden treasures, guiding explorers to potential hotspots with remarkable precision. Its ability to penetrate the earth's surface and detect metallic objects makes it an invaluable tool for archaeologists and treasure hunters alike.



## **4. Bionic System:**

Blending advanced biometric sensors with cutting-edge algorithms, the bionic system opens new avenues for treasure detection by tapping into the realm of biological signatures. By interpreting minute physiological cues emitted by living organisms or organic materials, this system reveals hidden treasures with unparalleled accuracy, even in challenging environments such as dense forests or underwater terrain.

## **5. Ion System:**

Embracing an environmentally friendly approach to treasure hunting, the ion system revolutionizes the way explorers uncover hidden riches. Through the analysis of atmospheric ionization patterns, this system identifies areas with heightened ion concentrations, signaling the presence of buried treasures beneath the earth's surface. Its non-invasive methodology minimizes ecological disruption, making it an ideal choice for conscientious adventurers seeking to preserve the natural world while embarking on thrilling quests for discovery.



## 5. 3D Scanning:

Introducing the latest addition to the treasure hunter's toolkit: the cutting-edge 3D ground scanning system. This innovative technology revolutionizes the way adventurers explore the terrain by providing a comprehensive three-dimensional representation of the ground beneath their feet. Unlike traditional detection methods, which rely on single-point readings, the 3D ground scanning system offers a holistic view of the landscape, enabling users to visualize underground structures, anomalies, and potential treasure sites with unparalleled clarity.

Equipped with advanced sensor and imaging algorithms, this system captures detailed data about the subsurface environment and generates 3D images. These option comes into an android application that user can install on Android phones or tablets, allowing users to view and analyze the terrain from any location.





## LRL Single person (Long Range Locator) Systems

for using LRL system Connect the GEO device with the main unit with the GEO connection cable and plant it into the soil for at least 10 cm.





Power ON the main unit using the power button on the keypad and wait until the device finish booting. Then power ON the LRL device using power button on the LRL device keypad.

Wait until the connection between the two devices is done successfully.



  
**Connected**



**B/I**

when connection done an icon in the top of main unit screen will appear with playing sound message means that the connection is established



Then connect the RODS with the LRL device using the specific connection cables.

### Single Person RODS

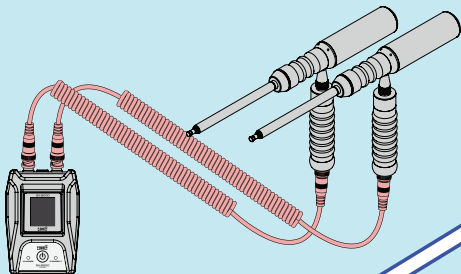

### Double Person RODS

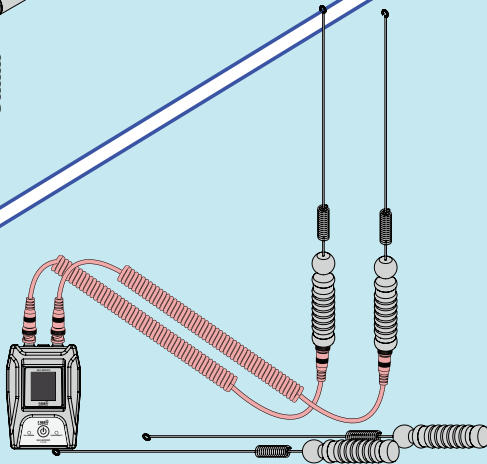

**Note:** use Single person RODS for single mode or double person RODS for dual mode



in the main unit screen select Long Range system from main menu using left and right arrows and press OK button

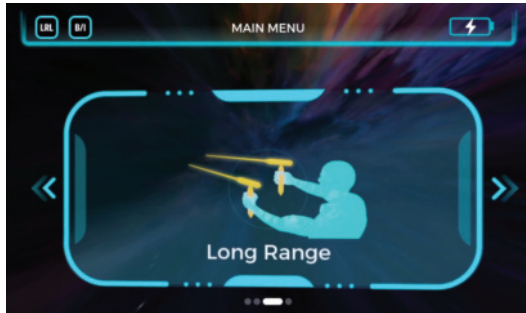

in this screen user can set all scan settings that is:

MODE  
TARGET  
SOIL  
DISTANCE  
DEPTH  
SUMMARY

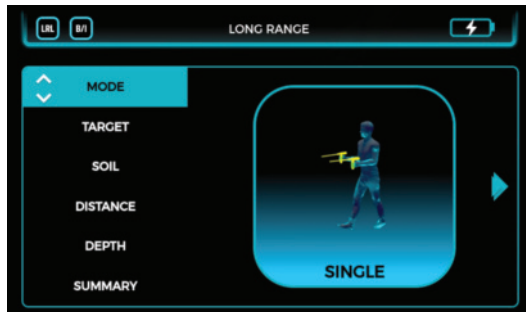



To move between the options user must use UP/DOWN arrows and to change between the option values user must use LEFT/RIGHT arrows on keypad

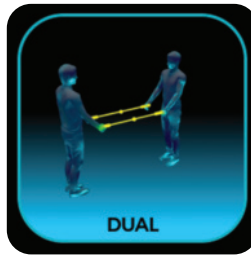

### MODE

In this option user can use two different modes for  
Single Mode (Single Person)  
Dual Mode (Double Person)

### TARGET

In target option user can select a target type from the list  
The target types are:



Bronze	gold treasure
cavity	gold veins
copper	iron
diamond	platinum
gold	silver



## SOIL

In soil option user can select a soil type from the list

The soil types are:

Normal	Dry
Rock	Snow
Stony	Low mineral
Wet	High mineral

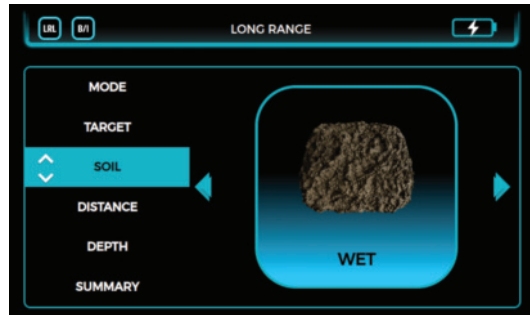

## DISTANCE

User can set the maximum distance to scan between the device and the selected target type





## DEPTH

User can set the maximum underground depth to scan between the device and the selected target. User can choose depth between 1 meter and 50 meter maximum



## SUMMARY

In this option user can see all the chosen setting



After setting the system and while you are in SUMMARY screen press OK button to switch to scan view. In the LRL Scan view user can see an animation shows how user must use the system according to selected LRL System Mode.

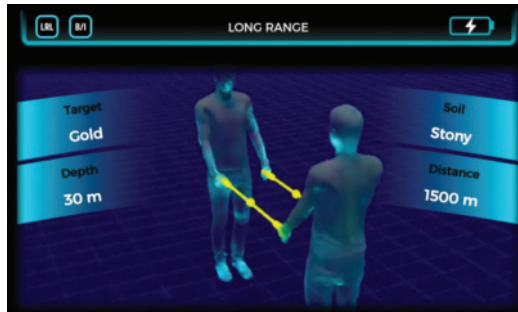

Note: at the same time all chosen setting will show in LRL device screen.

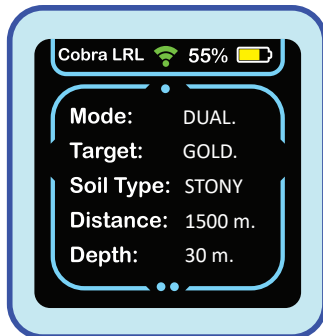





## How to use LRL single

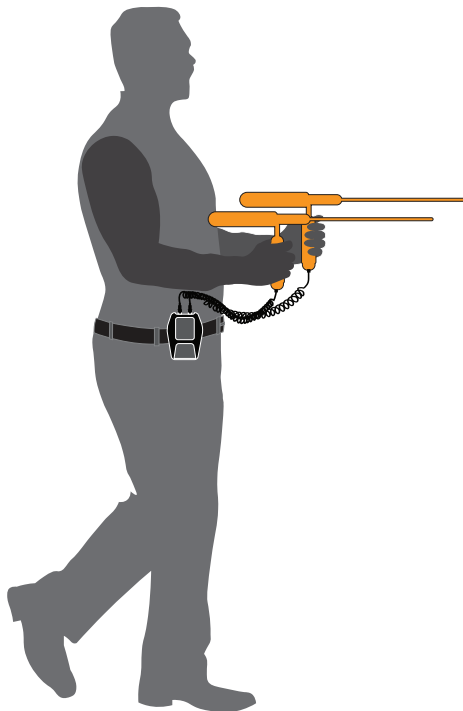

After setting up the search settings and entering the search screen, Connect the LRL device with the specific cables to the RODs and hang the device on your belt.

hold the metal RODs as shown in the figure and start moving. To search in the search area, you can do one of the following two ways:

### **1) Zigzag Path**

### **2) V Shaped Path**

Both of the mentioned methods alone are sufficient for searching, but it is suggested to perform both methods together to be more sure of the correct target during searching.



### 1) Zigzag Path

The user must advance according to a zigzag shape as shown in the line drawn in the following figure, from north to south, following the direction of rotation of the rods (in case there is a target).

In this type of search, the user must move according to the mentioned path, and we note that the direction of rotation of the rods is concentrated according to a specific point with more progress towards the supposed target, this point is the location of the buried target. To make sure of the exact location of the target, it is preferable for the user to repeat the above-mentioned process from different directions towards the point that was first identified. If the found point is confirmed, this point (X) is an assumed location for the potential target.

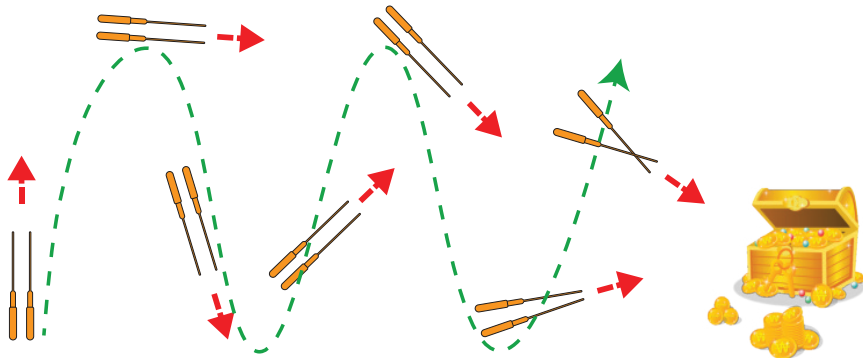



## 2) V Shaped Path

After finding the mentioned point (X) in the previous paragraph and to make sure that the target exists, that is, the target is real and the signals are not false, then the user must move from point (X) a few meters towards the north and identify a new point (A) and then advance towards the south of the point (A) according to the right and left sides of the point (X), as shown in the picture below.

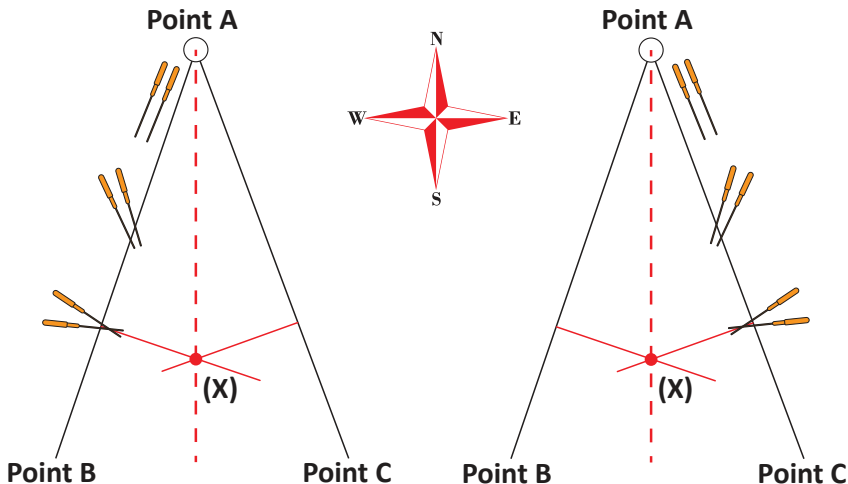





## How to use LRL DUAL

After setting up the search settings and entering the search screen, Connect the LRL device with the specific cables to the RODs and hang the device from your belt.

the two person must hold the metal RODs as shown in the figure. To search in the search area, follow the procedure below:

stand at a point in the search area and hold the RODs in your hands as shown in the picture, then wait for about a minute. Pay attention not to pull the RODs too hard, and ensure they are not too loose. If there is no change in the state of the RODs , change your position and repeat the operation. Continue repeating this process until the head of the RODs tilts to one side.

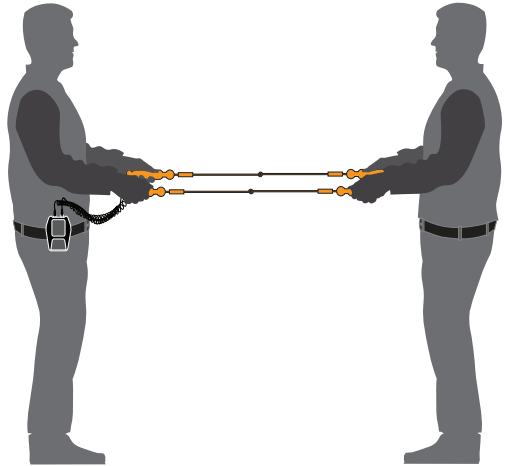



If the RODs slip, move a few meters in their direction and repeat the operation.  
Repeat the last operation several times to alter the direction of the RODs.  
The different modes indicating changes in the skewers are as follows:

1. The head of the RODs tilts to the left: it means that you should move to the left and repeat the operation.

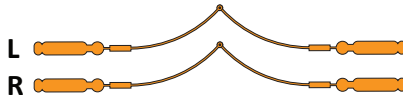

2. The head of the RODs tilts to the right: it indicates a shift to the right is necessary, then repeat the operation.

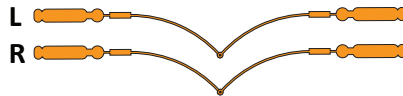

3. Both person RODs separated from each other: this suggests there is a void or hole underground.

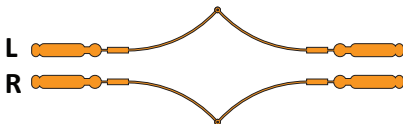



4. Both person RODs intersect each other in an X position or both tilts downwards: indicates the selected target is underground.

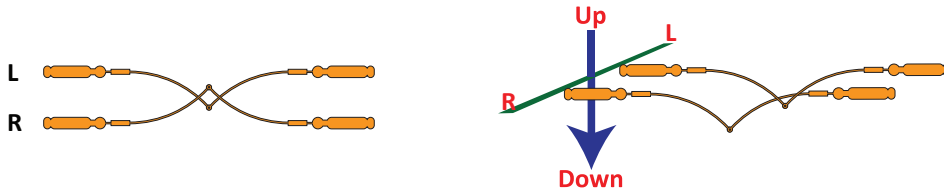

5. The head of the RODs rises: it signifies a target or gap behind one of the two persons. In this case, both persons should turn 90 degrees and repeat the operation, then wait for the results mentioned in paragraphs 1 to 4."

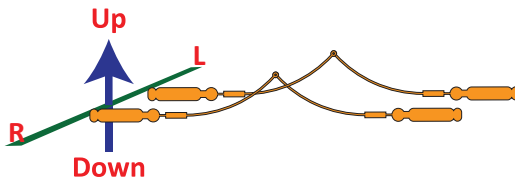



## IONIC Search

Since the invention of metal detectors until now, knowing the ionic search system has been developed according to a completely new technology, which is the first of its kind in metal detectors, and represents a major improvement over the traditional system that existed before.

Where the new technology allows more accurate detection of ion fields resulting from metal targets buried underground that ensures accurate reception and processing of signals, with the ability to control some of the signal settings on the screen to ensure accurate results.

Cobra GX-8000 PLUS is supplied with two ionic systems, which are called Ionic and Ion. These two systems are used to easily analyze and check the ion signals of the search area. In the following, we will describe these two systems and how to use.







## IONIC System

As mentioned, the ionic system is a new system made in Geoground company, which is unique in its kind. The ionic system monitors the presence of ionic metals or closed cavities in the environment by sending signals to the environment around the device's sensor and receiving their feedback.

### How to use:

Install the I.B.I Sensor and the wireless handle to the device as it shown below

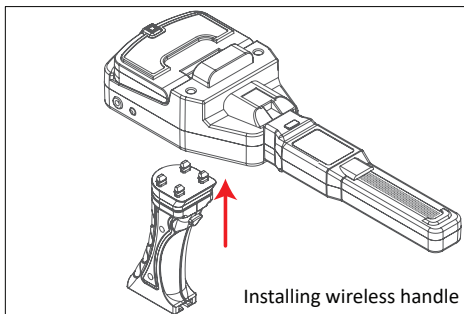
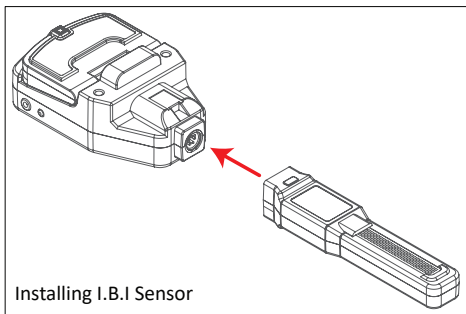



Turn on the main unit and the IONIC unit and wait until the connection between the both device done successfully.



when connection done an icon in the top of main unit screen will appear with playing sound message means that the connection is established

**B/1**

In the main unit - main menu, enter the Ionic system and choose the Ionic option from the two available options

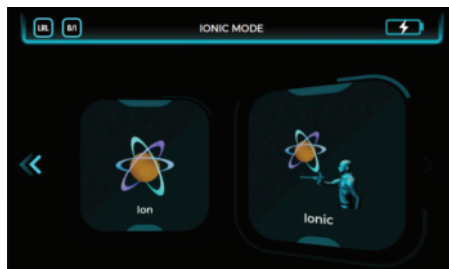

in the screen of main unit, an animation will appear that shows a simulation of the scan process with a message says that «CONNECTED - IONIC»





user can see the IONIC search result in the IONIC unit screen with two separate box called «Target» and «Cavity»

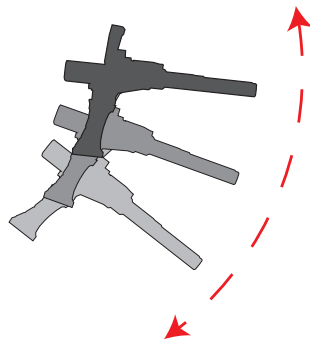
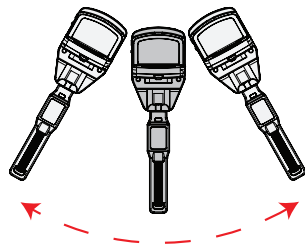

For starting after entering Ionic page, user must press on start button out of search area in opposite direction that the user want to search in, to calibrate the sensor. Then move the device slowly UP-DOWN and LEFT-RIGHT with the same speed, while the device is slightly lowered towards the ground.



In case of a presence of close target signal, the target progress bar on the screen will show the captured signal percentage with green to red color depending on the signal strength.



However in case of a presence of close cavity signal, the cavity progress bar on the screen will show the captured signal percentage with green to blue color depending on the signal strength..





## ION System

It can be said that the ION system works like the IONIC system, with the difference that in this system the device will search only for ion signals and due to the elimination of cavity signals, more signals are focused on metal targets, which increases the accuracy of frequencies and finally leads to better results.

### How to use:

Install the I.B.I Sensor and the wireless handle to the device as it shown below

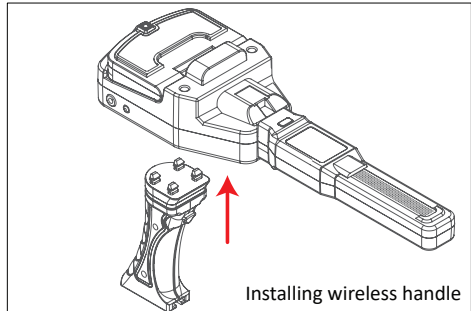
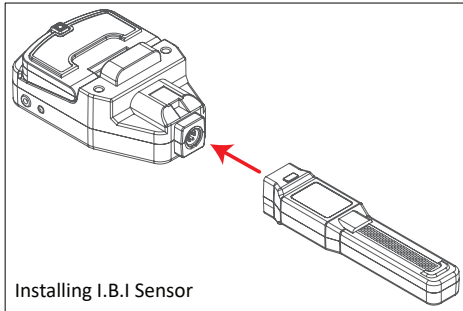



Turn on the main unit and the IONIC unit and wait until the connection between the both device done successfully.



when connection done an icon in the top of main unit screen will appear with playing sound message means that the connection is established

**B/I**

In the main unit - main menu, enter the Ionic system and choose the ION option from the two available options

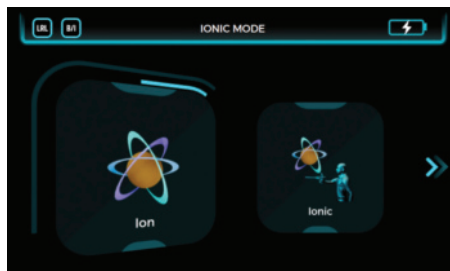

in the screen of main unit, an animation will appear that shows a simulation of the scan process with a message says that «CONNECTED - ION»



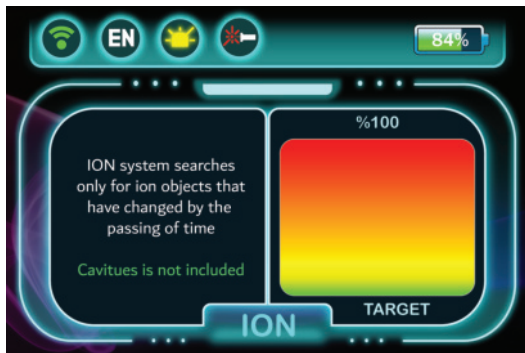

user can see the ION search result in the IONIC unit screen with a box called «Target».

For starting after entering Ionic page, user must press on start button out of search area in opposite direction that the user want to search in, to calibrate the sensor.

Then move the device slowly UP-DOWN and LEFT-RIGHT with the same speed, while the device is slightly lowered towards the ground.

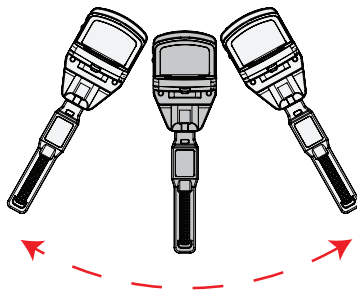
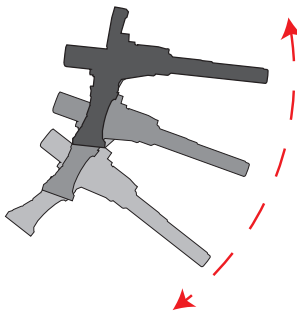



In case of a presence of close target signal, the target progress bar on the screen will show the captured signal percentage with green to red color depending on the signal strength.

Emphasizing that there is no search for Cavities in this system

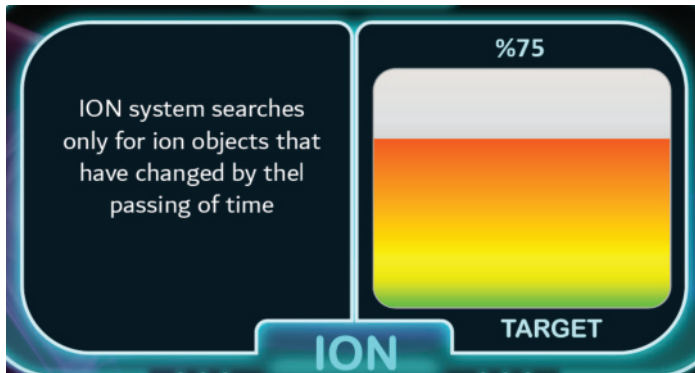





## BIONIC System

This search system is similar to the ionic search system in terms of Working method .The difference, however, is that here, Bionic signals are captured from a specific metallic object. For example, from gold, then the search is directed towards capturing Bionic signals similar to metal objects buried underground within the surrounding area.

That means, in the ionic search system, the search is random and free, but in the bionic system the search is directed according to a specific target type, that is, according to predefined signals.





## How to use:

Install the I.B.I Sensor and the wireless handle to the device as it shown below

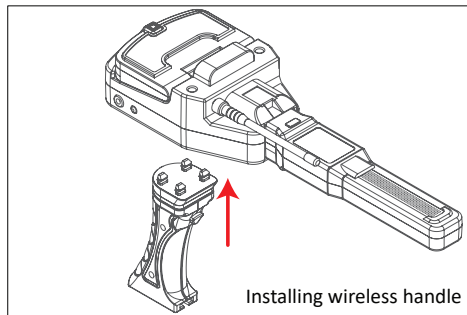
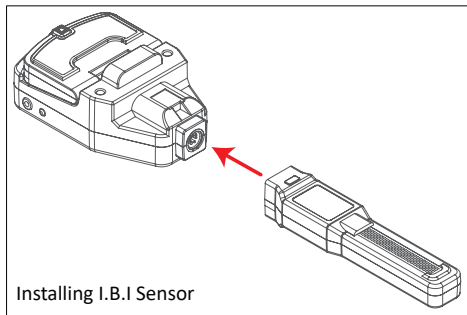

Turn on the main unit and the IONIC unit and wait until the connection between the both device done successfully.



**B/I**

when connection done an icon in the top of main unit screen will appear with playing sound message means that the connection is established

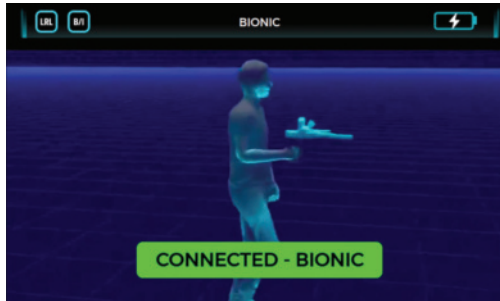

Enter the BIONIC system from the main menu. if the IONIC device is connected to the main unit a screen will appear that says «CONNECTED - BIONIC» with an animation simulating how to work with Bionic System.

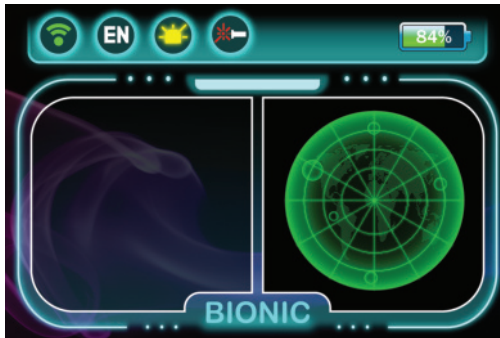

In the IONIC device the BIONIC system will activate as shown in the following image.



Point the I.B.I Sensor head at the metal object of the model target type you want to find and then press the start button on the device handle, to set the target type.

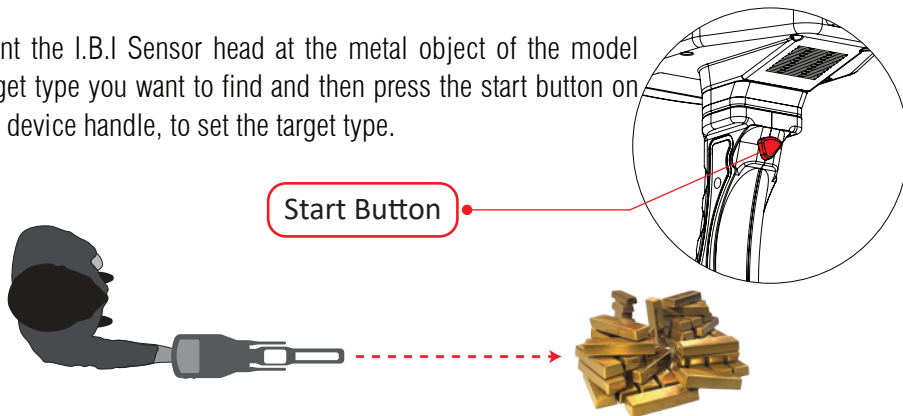

User can fix the device direction on the scanned object using the laser light. This will help to capture the exact needed object signals.

**Note:** There is no reset in this system, so in any point which we press the start button, will be the new field on which to match.



By using this system, we move the unit of the Bionic system in all directions slowly, in case there is a close signal, it will appear on the indicator on the screen.

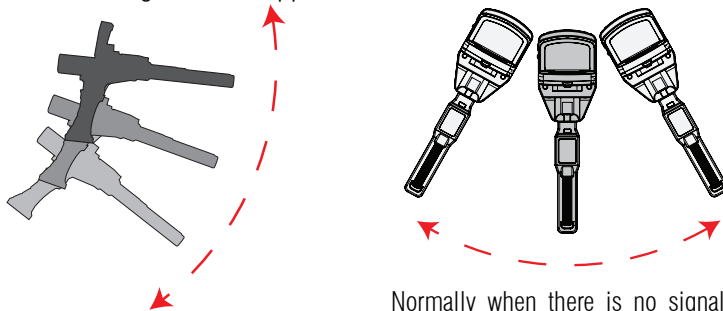

Normally when there is no signal like which captured before, a green motion circle will appear on the bionic screen.

The indicator in this system will appear stably and with color red in case of a founded signal is similar to the captured signal, in conjunction with a sound alert indicating the target.

In the event that the signal appears, it can be confirmed by returning to the first metal object and repeat the operation again.



## GEOGROUND 3D analyzer

The new Cobra device series comes with a 3D scanning system. This system, along with other systems in the device, makes it easier for explorers to reach their goals.

The 3D scanning system with the ability to detect holes and ionized metals and display them in the form of colors and categorized values on the analyzer software platform helps a lot in the analysis of search locations.

Enter the **Google Play Store** on your smart device, and write in search field “Geoground 3D Analyzer”, the app will show you immediately. Install the application on your smart device and follow the steps below to connect with your new device.

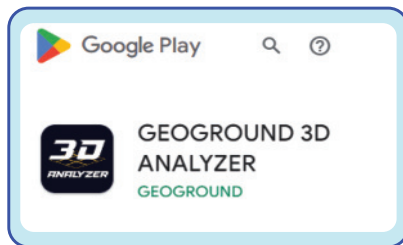

**by scanning this QR Code also user can open download page on google play stor directly.**





After launching the app, you will first see an alert to start searching for your device, choose your device from the list of available devices and give the necessary permissions to the app for the connection.



Note: In order to quickly connect or disconnect, we press the connection icon located in the status bar at the top of the main screen. if it`s the first time that the device is connecting to the app. by pressing the connection button a connection screen will appear. by press on the scan button in this screen a list of all available devices will load. select the device and press on connect to establish a connection with the device



After entering the 3D ground scanning option in the main menu, the 3D system settings screen will appear. In this screen, the user must adjust all necessary scan settings according to the area and the target that the user needs to scan.



This setting helps the user to make the scan with more accuracy so it helps the application to analyze the scan and give the user the best results

These settings are:

Path

Direction

Type

Lines

Pulse





**1-Path:** From this option, we can specify the path by which we want to search.

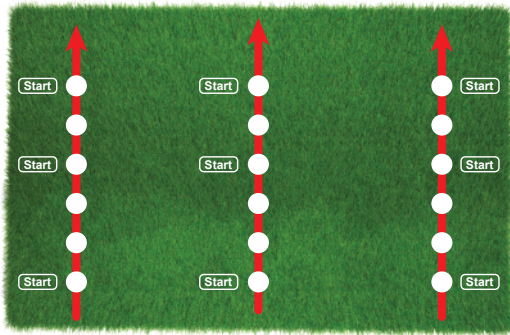

### Parallel Path:

In this path, the search lines are straight, parallel, and equal lines before the start of the first line, and at each step you take, the user must press this start button if we have chosen the "manual" search type.

We also always recommend that the distance between one step must be about 30cm. We repeat this process for each line we take, until we have finished all the marked lines. (Please read paragraphs 3 and 4 on the following pages for how to calculate the number of lines and pulses in both the parallel and zigzag paths).



## Winding (Zigzag) Path:

In this path, follow the zigzag method, as shown in the drawing on the side, remembering to press the Start button at the beginning and end of each step you take in this path. We also always advise that the distance between each step most be about 30cm as well.

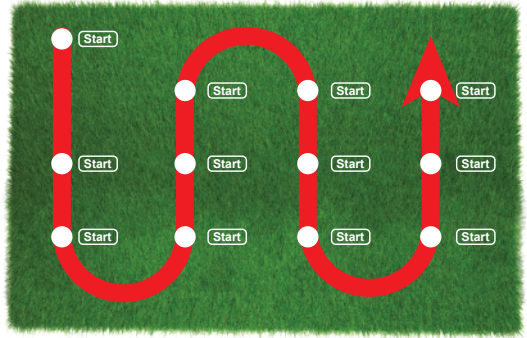

**2- Direction:** the angle of the search area

From this option, we can select the starting point from which the search will start, so that this point is in one of the corners of the specified search area.

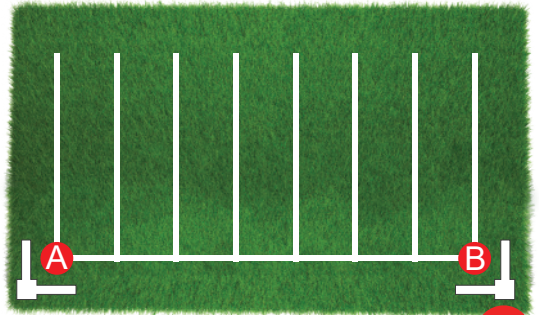



If we are going to start the search from point A, for example, we must specify this direction drawn as follows ( ) in the “Direction” option from the system settings, and vice versa for point B.

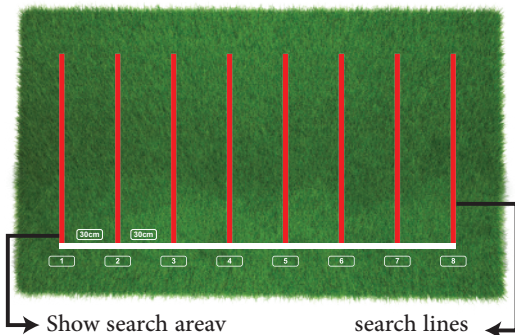

### 3-Lines:

The process of calculating the number of trajectory lines in the search area: Let's say first that we want to search in an area 3 meters wide and 3 meters long, we divide the line of latitude that we drew into parallel and

longitudinal lines "based on it" so that the distance between each line and the other is 30cm, In this case, we will produce "almost" a total of 10 lines based on the latitude that we previously determined. You write the number of lines that we calculated, which is 10, in the “Lines ” field of the system settings in the application.



**4-Pulses:** The process of calculating the number of pulses for each line in the paths: The “number” of pulses is the number of times we will press the Start button on the wireless handle while searching in the path lines. To calculate the number of pulses in the search lines..and as we previously assumed that the length of the area The search is 3 meters, that is, the length of the lines that we specified in the previous paragraph will be 3 meters as well. We divide the line of longitude or the previous lines into equal sections, or we call them pulses, so that the measurement of one section or the distance between each pulse and the other is 30 cm. In this case, we will have "Almost" with a total of 10 pulses in each of the lines that we previously defined. We write the number of pulses that we calculated, which is 10, in the "pulses" field of the system settings in the application.

The white lines in this drawing indicate the search lines that we identified in the previous paragraph, while the red lines drawn on the white lines express the impulses that we will make in these lines.

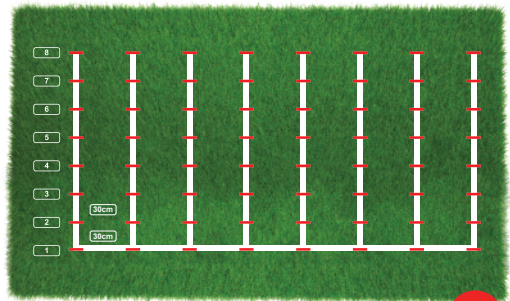



## 5- Type :

or search type, by this option we can choose how pulses are recorded either automatically or manually, When selecting "Manual" option the user have to press Start button located on the wireless handle of the device at each step by step in one of the previous paths (as shown in the previous paragraphs, this is in contrast to the "Automatic" option so that the application here calculates the number of pulses in each A search line from the automatically selected paths, meaning there is no need to press the Start button manually at each step, but the user will have to press Start at the beginning and end of each line only.

After completing all the previous settings, we press the "Start Scan" button at the bottom of the screen.. Skip the video tutorial and start searching with the previous settings.

**Start Scan**



We will notice that with every step we take in the paths, the application will start drawing 3D details. Complete the search process as we prepared it until a window appears on the screen stating that the search process has been completed successfully.

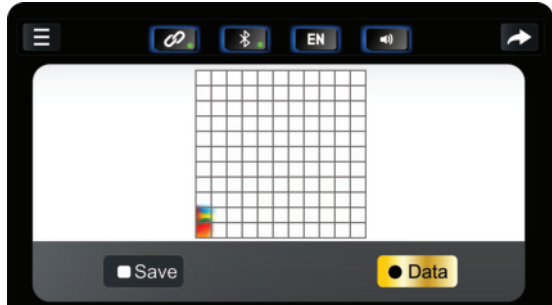

We review the result of our search. Then we save our search file, in order to view and analyze the file later.



by selecting each file in the saved file list. user can have multi tools to analyze the scan result in this file such as:

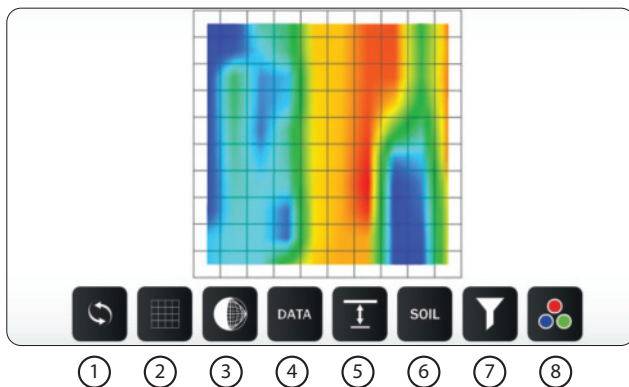

- 1-Reset&drawing view for the automatic and main mode.
- 2-The ground grid or the surface of the search area.
- 3-The wireframe or solid vision of the drawing.
- 4-Search results data.
- 5-The approximate depth in each search box (grid cell)
- 6-Soil for the search area,choose... the appropriate type of soil from 15 natural types - cement - clay - sandy - clay - high minerals - low minerals - rocky - fresh water - salty water - snowy - permafrost - charcoal - granitic - saline.



7-Color filter It is used to hide one of the colors of the drawing.



Metal



Cavities



Normal



Metallic  
field



Cavity  
Field

8-Color themes of drawing color gradations.

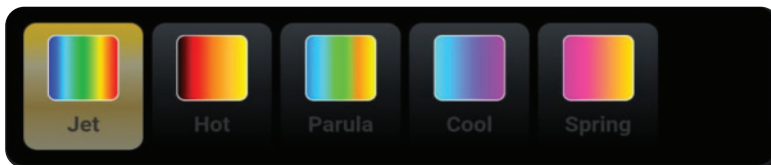

We can refer to the file of the search we have done at any time we want through the files section of the application.





## Application Settings

this app support eight different languages.

in the settings user can change the preferes language by selecting one the folowing languages.



We can also change the language faster by returning to the main menu and pressing the language icon on the top bar. A list of the eight available languages will appear.



## Connection

From the connection option in the settings, we can access the option to connect the device to the application, or to disconnect with the device. We can also access the speed dial feature from the dial icon in the top bar of the main menu.

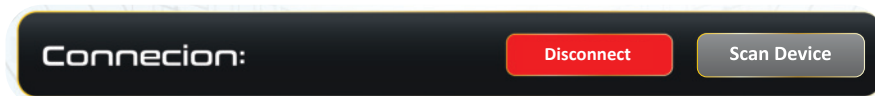

It should also be recommended to open Bluetooth before starting to connect the device, or to give permission to the application to automatically open Bluetooth technology. We can turn on bluetooth from the bluetooth icon present in the status bar.



## Permissions

To turn on or off an app's permissions (location, storage, bluetooth), we can just click on the box next to the option.

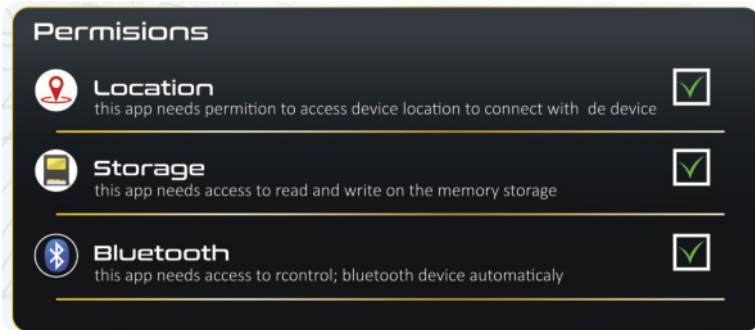

In order to access information about the Geoground company or information about the device connected to the application, we can click on the right pop-up window.



## Main Unit Settings:

To adjust the device settings, go to Settings Item in the main menu and press on OK.

In settings there is four items in the list:

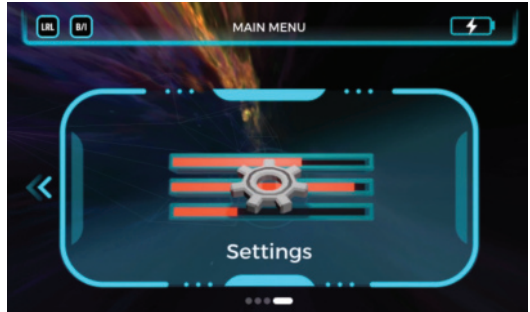

**Language**

**Volume**

**Brightness**

**About**

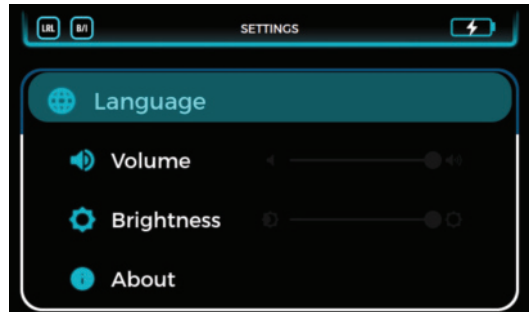



## Language:

This device comes by 8 Languages such as:

German	Spanish
English	Persian
French	Turkish
Arabic	Russian

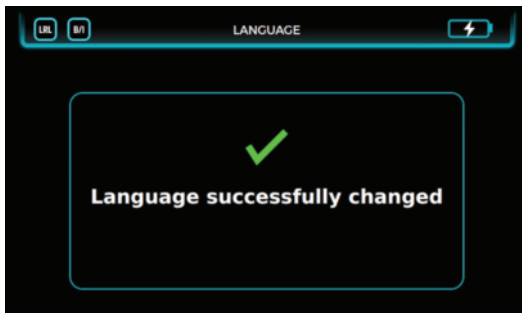

to change the device language select your preferred language by using left/ right and up/ down keys on the keypad then press OK

After changing the language, a message will appear says that “Language successfully changed”



## Volume:

By using this item user can control the device sound level.

When this item is selected user can change the sound level by using left/right arrows

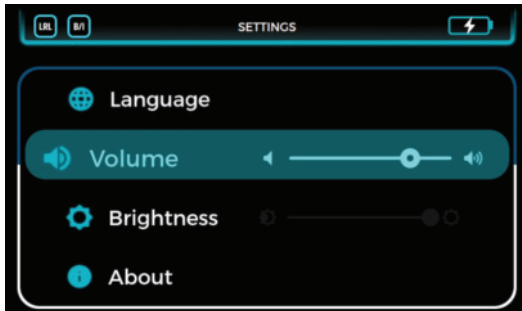

## Brightness:

By using this item user can control the device screen brightness level.

When this item is selected user can change the screen brightness level by using left/right arrows

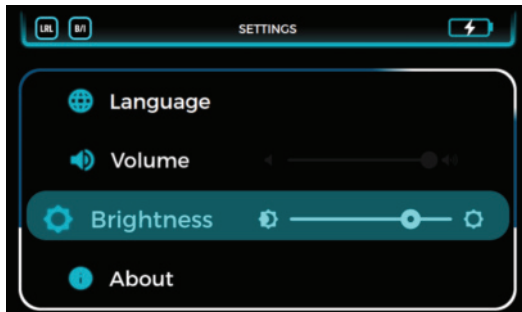

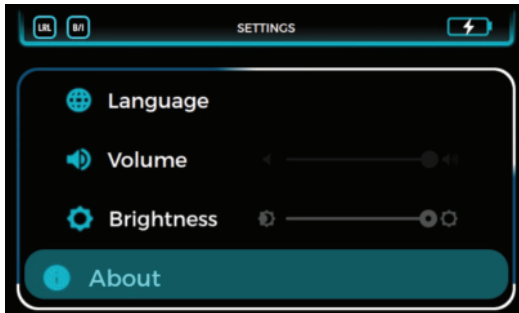

## About

By selecting this item user can see all information about the device such as :

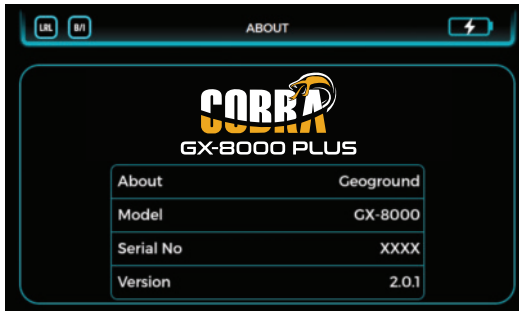

Manufacturer  
Model name  
Serial number  
Software Version



## IONIC Unit Settings:

To adjust the IONIC unit settings, press on Settings button on the keypad.  
In settings there is four items in the list:



### Sound

Brightness  
Sensor LED  
Info

### Sound:

use this option to adjust the device sound volume

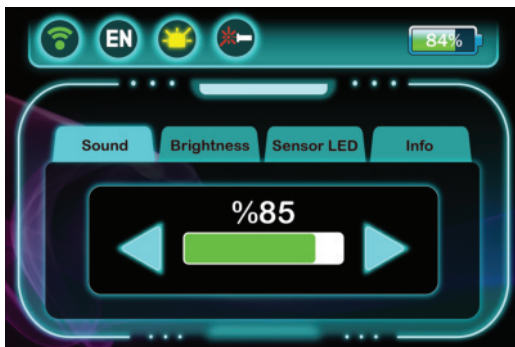



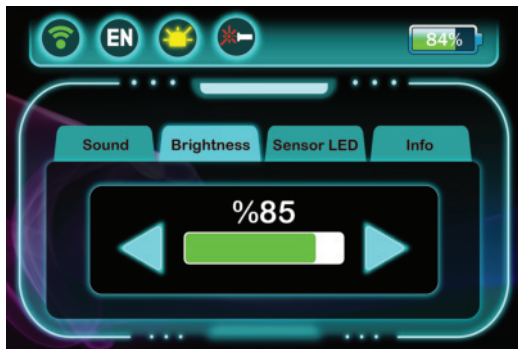

### Brightness:

use this option to adjust the device screen level.



### Sensor LED:

user can use this option to turn ON/OFF the sensor LED.

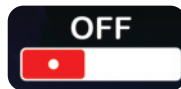



## Info:

in this option user can see the device information such as:

Software version

Model Name

Serial Number

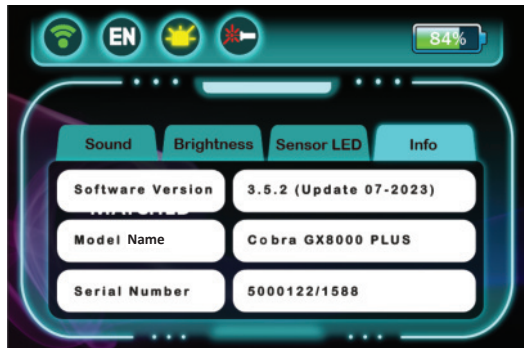

## Note:

when the user turned the device ON the connection screen is shown always. this screen will inform the user about the connection status.





## Status bar:

In the top of main screen there is 4 Icons that represent the following device options:



### **Battery:**

this icon shows the battery capacity status



### **Lazer:**

this icon shows the laser status. laser will automatically on when user starts BIONIC system



### **Flash light LED:**

if the device Flashlight is on this icon color is yellow and in case of the device flash light is off the icon color will be white



### **Language status:**

this icon shows a symbol of the selected language



### **Connection status:**

if the device is connected to the main unit this icon will appear in green color and in case of the device connection with the main unit lost, the connection icon color will change to white.



Specifications		
Package Dimensions		86 x 43 x 17 cm
Package Weight		13 Kg
Material		ABS Plastic
Processor Type		ARM 64 Bit
Processor Frequency		1.4 Ghz
Storage Memory		32 GB
Memory Type		SD Card
Main Unit	Screen Type	High Resolution TFT LCD
	Screen Size	5 Inch
	Screen Resolution	1024 x 860
	Colors	16 million
Ionic Unit	Screen Type	High Resolution TFT LCD
	Screen Size	3.5 Inch
	Screen Resolution	480 X 320
	Colors	16 million
LRL Unit	Screen Type	High Resolution TFT LCD
	Screen Size	1.4 Inch
	Screen Resolution	240 X 240
	Colors	16 million



Specifications		
	Wi-Fi Connection	2.4 Ghz
Sound	Output	Speaker - Headset
	Jack Type	3.5 mm
	Headset	Wired Headphones
	Internal Speaker	Yes
Power	Battery Type	Lithium-Ion
	Battery Capacity	21000 mAh
	Fast Charging	No
	Removable Battery	Yes
	Languages	German – English – French – Spanish – Russian – Arabic – Persian – Turkish
Temperatures	Operation temperature	0°C – 40°C
	Storage temperature	-20°C – 60°C
	Humidity	5% – 75%



**GEOGROUND**

**GEOPHYSICAL GROUND MEASURING**



[WWW.GEO-GROUND.COM](http://WWW.GEO-GROUND.COM)