

BR 100 PRO

GOLD AND METAL DETECTOR



USER MANUAL

3 SEARCH
SYSTEMS

BR 100 PRO

User Manual

Safety information:

The components used in this device are subject to damage. Therefore, please adhere to the following information to maintain your safety and the device safety.

Before you start using the device, please read the manual carefully several times and understand it well, because the wrong use of the device may lead to damage or harm to the device.

You must pay attention and adhere to all information and warnings in the user manual before operating the device.

When assembling the device, make sure that all parts are connected correctly. And in case you need any assistance during the installation process, please contact the technical support team and ask for assistance.

After you have finished using the device, please return the device to its case to protect it from any possible damage.

The device must be stored in an environment free from negative electrical charges, away from moisture, and at a temperature below 50°C.

Turn off the device completely before saving it.

Make sure that the electrical socket provides the same voltage

Safety information:

indicated on the charger before plugging the charger into the socket.

If any of the following things happen, please contact the technical support team and request assistance:

- 1- A liquid substance penetrated the device
 - 2- The device was exposed to high humidity
 - 3- The device does not work well or you cannot operate it according to the user manual
 - 4- In the event that the device is dropped and damaged
 - 5- If there is a clear sign of damage or harm to the device
- Please keep the user manual for future reference.

Introduction

Thank you for your trust and purchase of BR devices
BR devices known worldwide for their efficiency in the field
of metal detection and locating gold and treasures with high
accuracy, now in your hands. This device will provide you with
the most accurate and best results during the search process
and you will be able to track the location of your target easily and
quickly, because BR devices are equipped with the latest and best
systems in this field.

For best results, please follow the information in this guide
accurately and correctly to reach your target.

Technical specifications

The BR 100 Pro is one of the newly developed devices by BR Systems, a well-known company in the field of metal detectors.

This version of the device outperforms its predecessors by providing greater capabilities and high-precision results

Screen : colorful screen 4.3 inch (480*272 pxl)

Battery : Li-ion Battery 7800 mAh/3.7 V – 20 hours.

Charger : USB – PD

Languages : English – French – Arabic – Spanish – Turkish – German

Casing : Safety suitcase designed especially for BR 100 Pro components and parts.

Warranty : Three years real warranty.

Technical specifications

The BR 100 Pro features 3 search systems:

1- Long-range search system: that has proven its effectiveness and ability to pinpoint targets, locations and depth with high accuracy.

The frontal distance that the device reaches: 1000 meters.

Maximum depth: 30 meters.

Targets: Gold, Gold Nugget, Silver, Bronze, Copper, Cavity, Iron, Aluminum, Lead, Tin, Water, Mercury, Diamond, Emerald, Ruby, Precious Metals and Custom Targe with a frequency up to (100.000KHz).

2- The ionic search system: which in turn is also the best system for detecting precious metals and ancient buried treasures buried hundreds and thousands of years ago with very high accuracy and with great ease.

3- Magneto Scan System: The latest audio system currently on the market and invented exclusively by BR Systems Company. This system is based on searching for electromagnetic fields for buried metals and voids.

Depth: up to 16 meters.

Package Contents and Components

The BR 100 Pro complete package contains:

- 1- Main unit
- 2- PowerMax Magnetic Sensor
- 3- Highly Polarized Sensor
- 4-Antenna x2
- 5-USB PD charger (TYPE C - 18W-3A)
- 6-Shock-resistant plastic bag

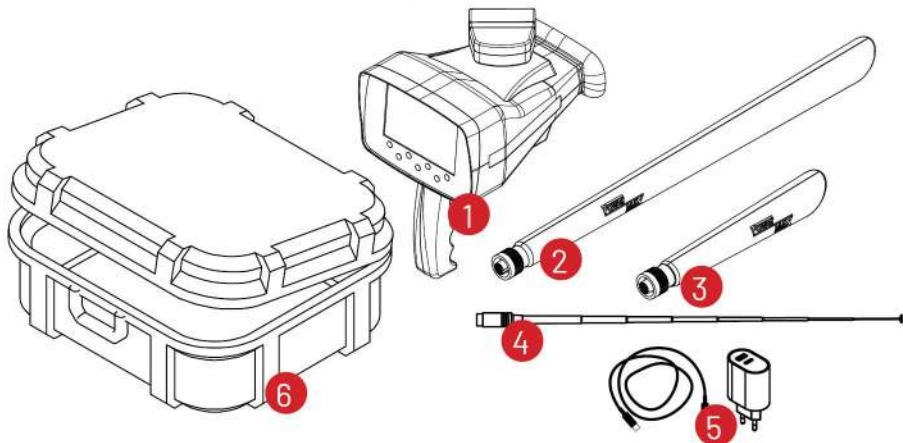

Device overview

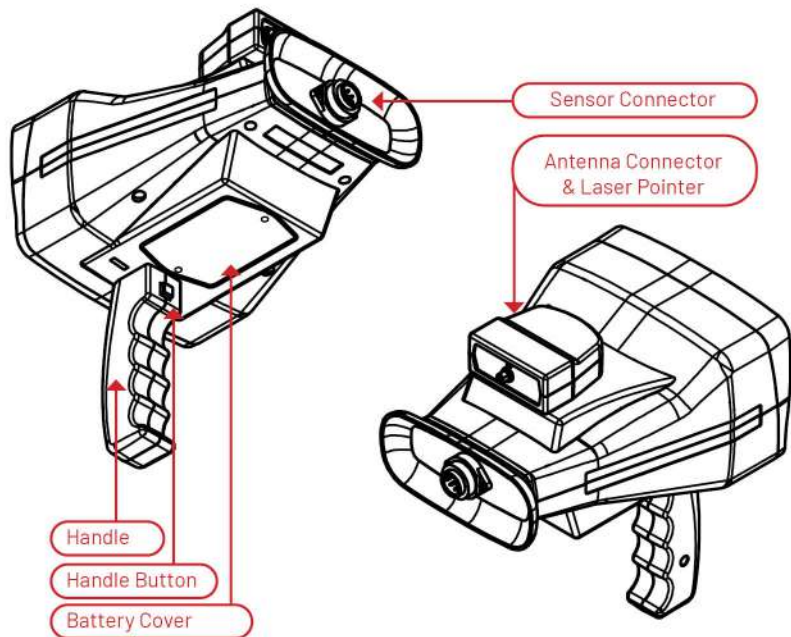

Keys & Buttons

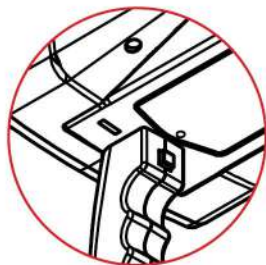

Power Button hold down to start or turn off the device, hold down for 15 seconds to force shut off the device.



OK confirms and selects options in the menus.



Back button cancels or retreat to previous page.



Left, Down, Up and Right buttons navigate through options and menus.

Handle Button activates Laser pointer and control search features.

Keys & Buttons

Power Button hold down to start or turn off the device, hold down for 15 seconds to force shut off the device.

OK confirms and selects options in the menus.

Back button cancels or retreat to previous page.

Left, Down, Up and Right buttons navigate through options and menus.

Handle Button activates Laser pointer and control search features.

User Interface



- 1- Current search system header
- 2- Sound Icon, it shows if the device is muted or unmuted.
- 3- Battery indicator, it shows if the battery health and charge status.
- 4- Time in 24 hours format.
- 5- Main Menu icons.

Select the search Icon or Setting and press OK to start using the device.

Settings

Press UP in the search menu and then OK to go to the device settings where you can browse the parameters and current setting values controlling the device.



Navigate through the menu using the arrow keys and press OK to enter the selected settings interface.



Settings

Display

Increase or decrease screen brightness and choose the power mode.

Brightness: There are two options, either light or dark mode

Sleep mode: The option can be selected between 15, 30, 45, 60 seconds to save energy and provide the ability to work for a longer time on the device



Sound

You can move the left and right buttons to increase or decrease the volume and

Turn on and off vibrate mode.



Settings

Time and date

The time and date can be easily adjusted via the directional buttons to increase and decrease values.

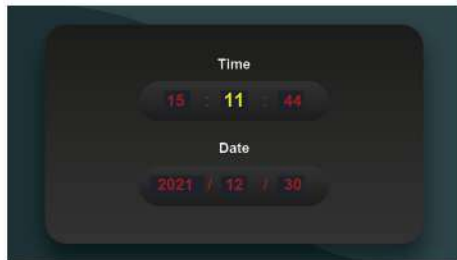

Language

The device contains 6 languages: Arabic - English - French - German - Spanish - Turkish



Settings

Device Info

Shows manufacturer, the device model and Software version

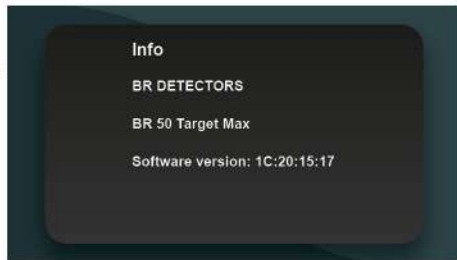

Reset device

Enables you reset the device.

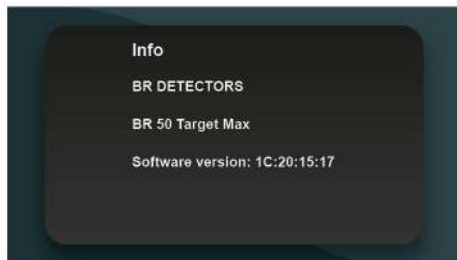

Settings

Battery information

It is complete information about the battery, such as the battery capacity, the amount of power consumption and the temperature of the battery to ensure the safety of the device and avoid any problem.



Long-range system

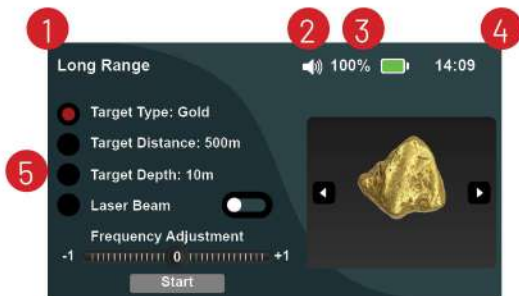

The system used in the search process in this device is the advanced and effective long-range search system.

1- Current search system header

2- Sound Icon, it shows if the device is muted or unmuted.

3- Battery indicator, it shows if the battery health and charge status.

4- Time in 24 hours format.

5- Search parameters.

Long-range system

The user can choose the target from the list of available targets:



Gold



Gold Nugget



Silver



Bronze



Copper



Cavity



Iron



Aluminum



Lead



Tin



Water



Mercury



Diamond



Emerald



Ruby



Precious Metals



Custom

Long-range system

If Custom target is chosen, press OK and adjust the frequency to match the desired value using the arrow keys, then press OK again to confirm. The maximum frequency for the Custom target is 100.000 KHz. Then choose the search distance up to the maximum distance of the device (1000m) Then choose the search depth up to the maximum depth of the device (30m). The user can turn on or off the laser pointer functionality. Press the handle button while searching to activate the laser.

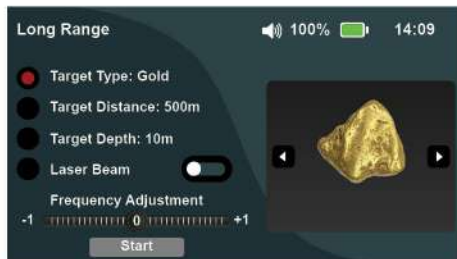

Long-range system

First, to ensure that you get correct results, you must stay away from all influences that may affect the validity of the search results, such as metal debris, cars, electrical wires, and high voltage lines near the device.

The search should be at least 200 meters away of previously mentioned objects.

The user has to point the device towards the south because the static electric fields send their waves from north to south.

After specifying all the options from the type of target, the front search distance to be searched, the depth you want to reach, and the appropriate frequency, the device must be held in the correct way as it is parallel to the ground and the arm is at a right angle against the chest.



Frequency Adjustment

The device is pre-programmed to its targets.

According to the searching area requirement the operator can adjust the frequency for the search by pressing Left and right in while the search is started.

For example let's explain how this tuning is done for gold. At your searching area, bury a couple of gold objects (can be any carat, for example 18 carat) gold coins, bracelets, chains etc and there is no need to bury them very deep for tuning.

Turn on the detector and come to the gold program then press enter for a couple of seconds after that the tuning screen will be on as on the figure, you will see that you can decrease or increase the searching frequency by at most 10 Hz with the left right arrow buttons. In other words every tuning grade changes the frequency about 1 Hz.

Gold's main frequency is 5000Hz as default. If you tune it to +5, frequency will increase about 5Hz and to 5005Hz. or for example if you tune it to -10, the frequency will decrease 10 Hz to 4990Hz. The operator must change the tuning and save the tuning when he/she gets the strongest response from the buried sample.

Long-range system

Press the start button, and then the device starts sending signals through the long-range signal transmitter, as these signals stimulate the static electric field of the specified target within the search field, if any, then the moving antenna begins to automatically attract towards those signals emitted by the target after repeating the search process from several directions. The antenna points to the same target location each time the user has to use the box method to locate the target precisely.

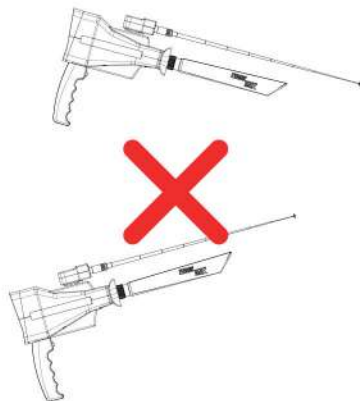
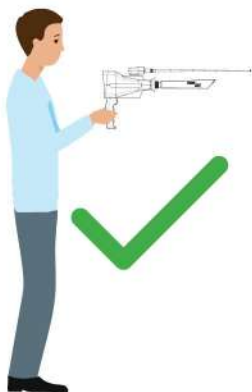

Enclosing on target using the “box” method

This method helps to more accurately determine the position of the buried target. The researcher draws a square around the previously found target at a distance of 150 cm from the center. When the researcher's feet are in the same direction as the target, the external antenna moves towards the target. Make sure at each of the four corners that the antenna is pointing in the same direction, and then you can know that the target you are looking for is the location of the signal that was placed and that the search process has been successfully completed.

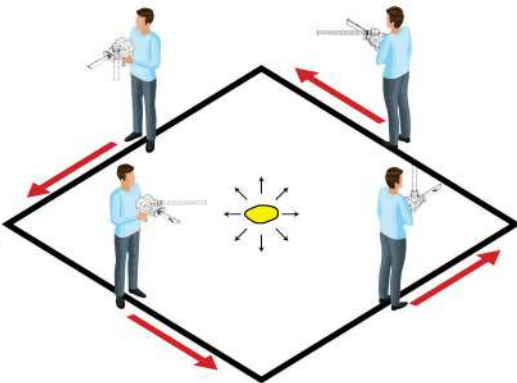

Determining target offset while drilling

In some problem areas, there may be errors in the target points that were identified with the indicator. For example, suppose we find an object at a depth of 3 meters when digging, after every half a meter the location of the target should be checked in a box manner, if there is an offset in the target, the drilling should be directed in that direction. This will take less time to dig and be more accurate. In similar areas, double-checking the target site with a normal coil detector will save more unnecessary drilling.

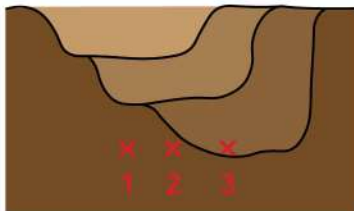
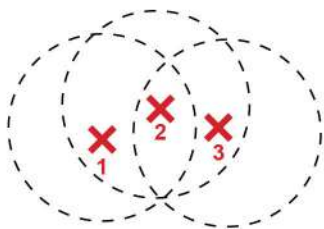

Ionic search system

What distinguishes this system is that it is not affected by electromagnetic signals whatsoever, as it is affected only by ionic fields formed by gold and treasures buried for long years (hundreds or thousands of years), so using this system is very easy.

Note:

The PowerMax Sensor should be connected prior starting the search



1- Sensitivity Bar: Adjust the sensor gain sense of the fields select a high value for finer targets or low value for a general search and prospecting.

2- Sense Gauge/meter: It indicates the sense level with a gauge and an overlay combined with audio feedback of the sense and target search.

3- Balance Bar: Adjust the value to zero out noise and random false positives.

Ionic search system

First you have to calibrate the device by lowering and raising the Sensitivity and Balance while moving the device a little up and down, and when the state of sleep is reached, the device becomes ready to start the search process, and then the user begins to move, where he can move on foot or even from inside a car. The ionic system is not affected by the signals emitted by the car and when approaching a target The pointer in the center of the screen begins to move and increase, and when you get closer to the target, it starts to emit a light sound that increases closer to the target with BR 100 Pro

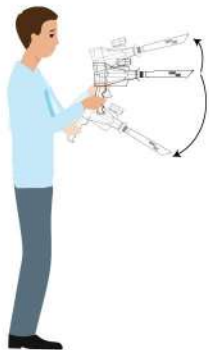

Magneto Scan system

Magneto Scan system: This system is characterized by its superior ability to find electromagnetic fields formed by metals and voids very easily, and this system also determines the center of the target with very high accuracy, what distinguishes this system is that you first: you do not need a long stick and discs of multiple sizes as in other audio systems. Second: the possibility of horizontal and vertical search. Third: The calibration of the device is very simple and also provides you with the automatic calibration feature. Once you start the Magneto Scan system, the device will be ready to search. It has been automatically calibrated to suit all prospectors and everywhere while maintaining the feature of raising and lowering the sensitivity and making the correct balancing. Once the device has reached the sleep state, you can start searching. The direction of the search must be fixed so that if you calibrate the device from north to south, you must continue in this direction, and when the sensor passes over a target (metal or void) the device will emit a sound and the indicator on the screen will rise and the type of target will be determined.

Magneto Scan system

The user interface for the Magneto Scan Search System consists of the following:



1- Parameters bars:

Balance: Sets the reference point for the sensor. Increasing or decreasing the zero point offsets the sense range into Positive or Negative value and skews the indicator towards one type of targets over the other.

Gain: Sets overall range of sense for the system

Sensitivity: Sets the steps and sensing grads for the sensor.

2- Sense indicator: shows the current reading of the PowerMax sensor. Usually metals tend to be on the max/positive side and Cavities/voids tend to be on the negative side.

3- History Graph: shows a history of the past readings to help the user enclose on a target and/or detect its shape.

Warranty Terms and Conditions

A. Extent of limited warranty

1. BR SYSTEMS warrants to the end-user customer that the BR SYSTEMS product specified above will be free from defects in materials and workmanship for the duration specified above, which duration begins on the date of purchase by the customer.

2. For software products, BR SYSTEMS limited warranty applies only to a failure to execute programming instructions. BR SYSTEMS does not warrant that the operation of any product will be interrupted or error free.

3. BR SYSTEMS limited warranty covers only those defects that arise as a result of normal use of the product, and does not cover any other problems, including those that arise as a result of:

- a. Improper maintenance or modification;
- b. Software, media, parts, or supplies not provided or supported by BR DETECTION;
- c. Operation outside the product's specifications;
- d. Unauthorized modification or misuse.

Warranty Terms and Conditions

4. For BR SYSTEMS products, the use of a non-BR SYSTEMS accessories does not affect either the warranty to the customer or any BR SYSTEMS support contract with the customer, However, if product failure or damage is attributable to the use of a non-BR SYSTEMS accessory, BR SYSTEMS will charge its standard time and materials charges to service the product for the particular failure or damage.

5. If BR SYSTEMS receives, during the applicable warranty period, notice of a defect in any product which is covered by BR SYSTEMS warranty, BR SYSTEMS shall either repair or replace the product, at BR SYSTEMS' option.

6. You can request warranty services through BR SYSTEMS or any approved seller or distributor.

7. In case of maintenance inquiry, you can request maintenance through our approved sellers or agents and the customer shall pay only shipping costs during warranty period.

Warranty Terms and Conditions

8. This Warranty Card will not be considered as valid until the customer fill the registration form on BR SYSTEMS TECHNOLOGY'S website, and warranty begins on date of purchase mentioned on warranty card.

Online Registration Form Link; <http://www.brdetector.com/register-check-guarantee/>

B. Limitations of warranty

NEITHER BR SYSTEMS NOR ITS THIRD PARTY SUPPLIERS MAKES ANY OTHER WARRANTY OR CONDITION OF ANY KIND, WHETHER EXPRESS OR IMPLIED WARRANTIES OR CONDITIONS OF MERCHANTABILITY, SATISFACTORY QUALITY, AND FITNESS FOR A PARTICULAR PURPOSE.

C. Limitations of liability

1. The remedies provided in this Warranty Statement are the customer's sole and exclusive remedies.

Warranty Terms and Conditions

2. EXCEPT FOR THE OBLIGATIONS SPECIFICALLY SET FORTH IN THIS WARRANTY

STATEMENT, IN NO EVENT SHALL BR SYSTEMS OR ITS THIRD PARTY SUPPLIERS BE LIABLE FOR DIRECT, INDIRECT, SPECIAL, INCIDENTAL, OR CONSEQUENTIAL DAMAGES, WHETHER BASED ON CONTRACT, TORT, OR ANY OTHER LEGAL THEORY AND WHETHER ADVISED OF THE POSSIBILITY OF SUCH DAMAGES.

Contact information

Mobile: +15208005005

Phone: +16029105755

Phone: +16022814566

Email: Info@brdetector.com

Website: www.brdetector.com

Contents

Safety information: -----	2
Introduction -----	4
Technical specifications -----	5
Package Contents and Components -----	7
Device overview -----	8
Keys & Buttons -----	9
User Interface -----	11
Settings -----	12
Long-range system -----	17
Frequency Adjustment -----	21
Enclosing on target using the “box” method ----	23
Determining target offset while drilling -----	24
Ionic search system -----	25
Magneto Scan system -----	27
Warranty Terms and Conditions -----	29



**SCAN
FOR INFO.**

